



GLINT

VERTICAL MULTI-DECK





Benefits & Specifications:

- User-friendly
- Simplified maintenance
- Easy access and ergonomic design
- Designed for modular configurations
- Large display area
- Easily adapted to retrofit projects

Dimensions (mm):

Height : 2050 / 2200

Length : 1250 / 1875 / 2136 (HC) / 2500 / 2812,5 / 3125 / 3750

Depth : 950 / 1020 / 1120

SYSTEM	OPERATING TEMP. °C	REFRIGERANT
REMOTE	-1 / +1 +2 / +4 +4 / +6	HFC blend HFC/HFO blend CO ₂ GLYCOL/WATER

HFC: R407A / R407F / R134a / R404A • HFC/HFO: R448A / R449A / R452A / R450A
CO₂: R744 • GLYCOL/WATER: R718

ACCESSORIES

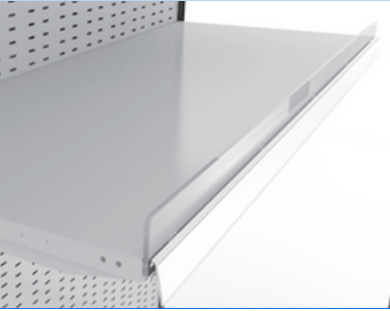

SOLID SHELF

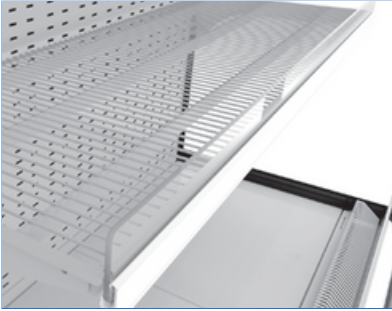

WIRE SHELF

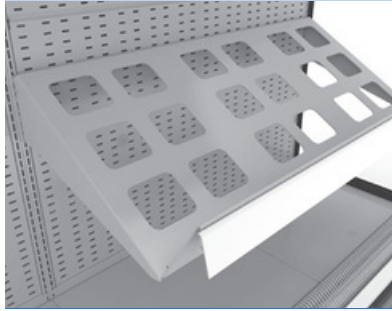

RACK SHELF

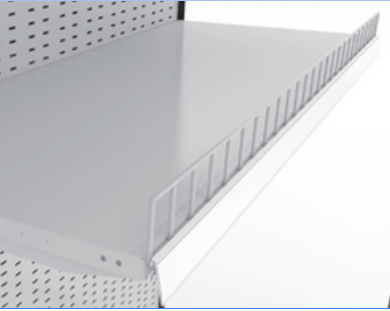

WIRE SHELF RISER



PLEXI SHELF RISER

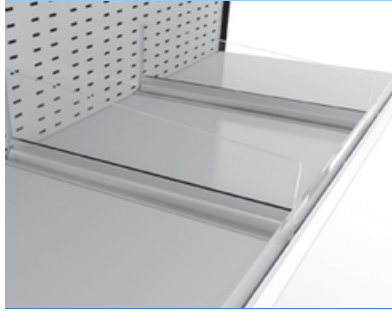

PLEXI PRODUCT DIVIDER

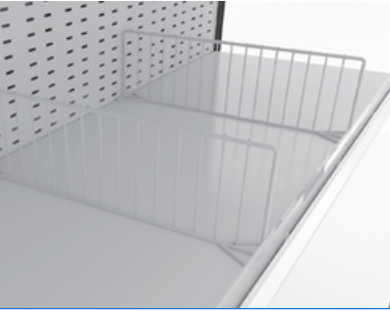

WIRE PRODUCT DIVIDER

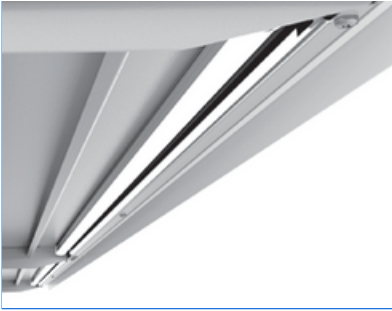

SHELF LIGHTING

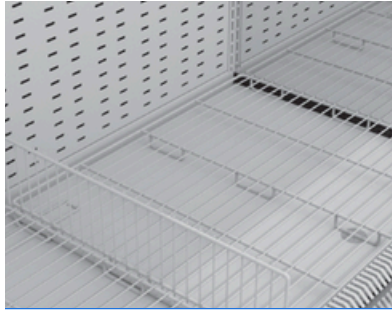

WIRE BASE TRAY
WIRE BASE PRODUCT DIVIDER

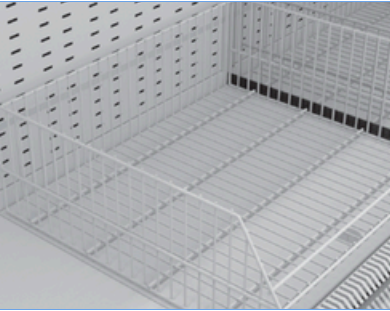

WIRE BASKET

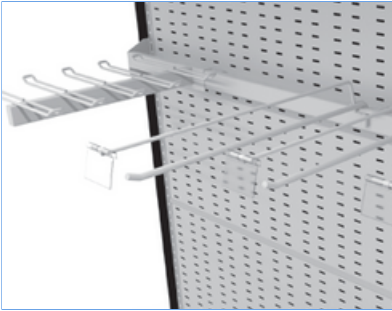

HOOK BAR



CABINET UPSTAND

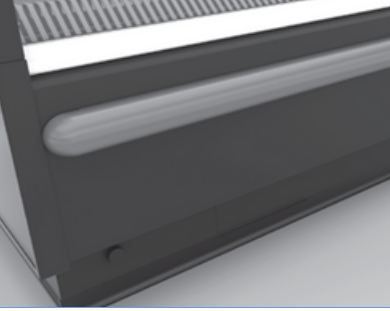

PLASTIC BUMPRAIL

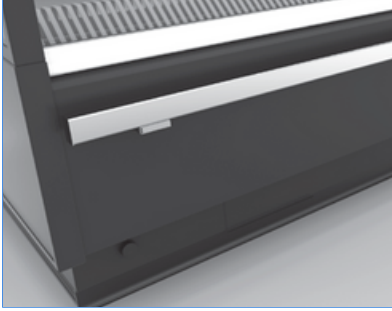

STAINLESS STEEL BUMPRAIL

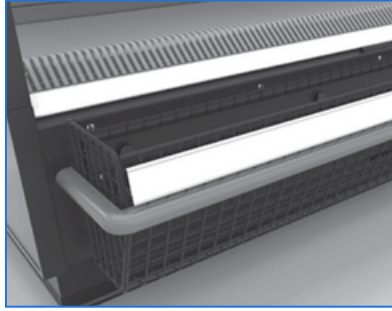

BASE FRONT CRISP BASKET



NIGHT BLIND

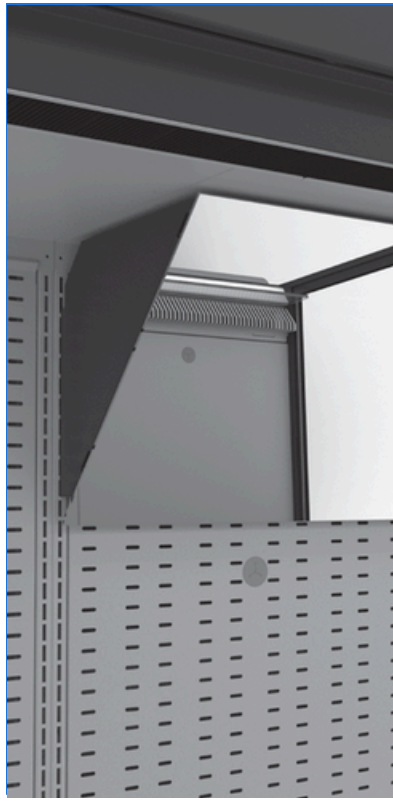

MIRROR (FV & MT)



ACRYLIC SYSTEM DIVIDE



PANAROMIC SIDE PANEL



INTERMEDIATE SIDE PANEL



MIRRORED SIDE PANEL

TECHNICAL DATA

HEIGHT 2050

DEPTH 950

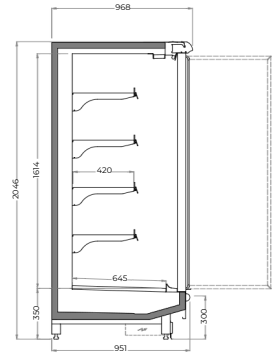
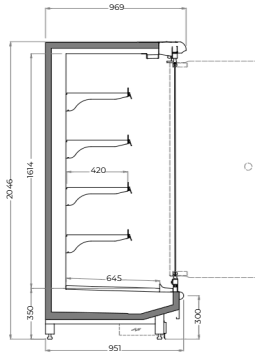
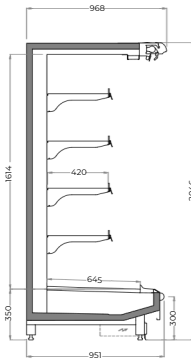

GLINT V3 2050 / 950

Length mm | 1250 | 1875 | 2500 | 3750
2812,5 | 3125 | 2136 (HC)

GLINT V3 2050 / 950

Length mm | 1250 | 1875 | 2500 | 3750
2812,5 | 3125 | 2136 (HC)

GLINT V3 2050 / 950

Length mm | 1250 | 1875 | 2500 | 3750
2812,5 | 3125 | 2136 (HC)

DEPTH 1020

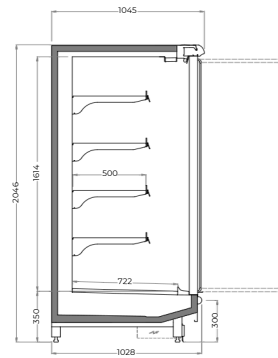
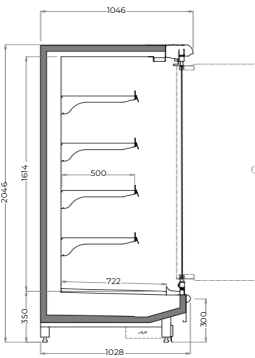
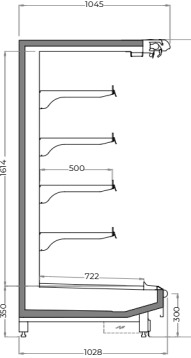

GLINT V3 2050 / 1020

Length mm | 1250 | 1875 | 2500 | 3750
2812,5 | 3125 | 2136 (HC)

GLINT V3 2050 / 1020

Length mm | 1250 | 1875 | 2500 | 3750
2812,5 | 3125 | 2136 (HC)

GLINT V3 2050 / 1020

Length mm | 1250 | 1875 | 2500 | 3750
2812,5 | 3125 | 2136 (HC)

DEPTH 1120

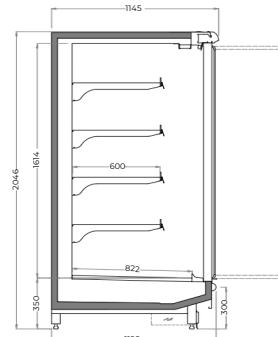
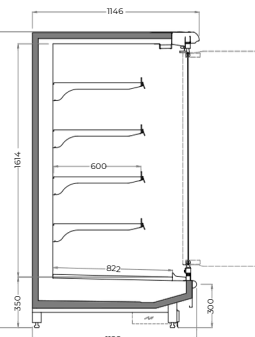
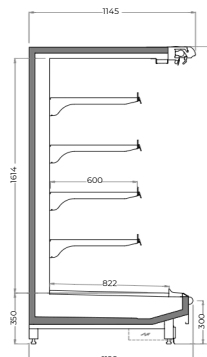

GLINT V3 2050 / 1120

Length mm | 1250 | 1875 | 2500 | 3750
2812,5 | 3125

GLINT V3 2050 / 1120

Length mm | 1250 | 1875 | 2500 | 3750
2812,5 | 3125

GLINT V3 2050 / 1120

Length mm | 1250 | 1875 | 2500 | 3750
2812,5 | 3125

HEIGHT 2200

DEPTH 950

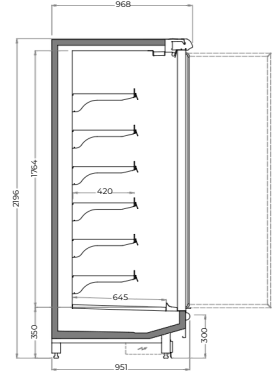
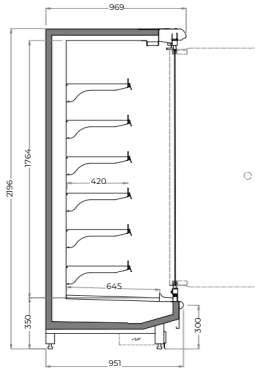
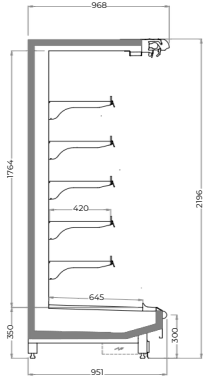

GLINT V3 2200 / 950

GLINT V3 2200 / 950

GLINT V3 2200 / 950

Length mm | 1250 | 1875 | 2500 | 3750
2812,5 | 3125 | 2136 (HC)

Length mm | 1250 | 1875 | 2500 | 3750
2812,5 | 3125 | 2136 (HC)

Length mm | 1250 | 1875 | 2500 | 3750
2812,5 | 3125 | 2136 (HC)

DEPTH 1020

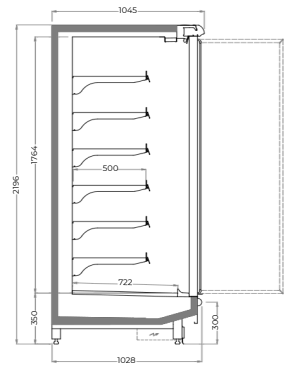
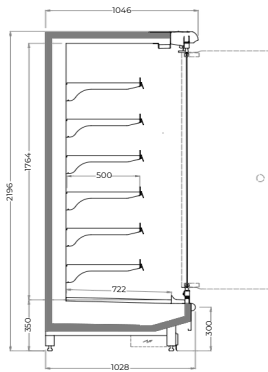
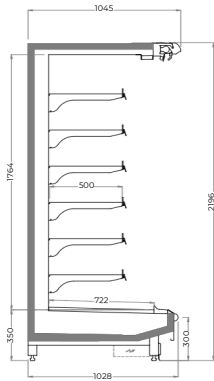

GLINT V3 2200 / 1020

GLINT V3 2200 / 1020

GLINT V3 2200 / 1020

Length mm | 1250 | 1875 | 2500 | 3750
2812,5 | 3125 | 2136 (HC)

Length mm | 1250 | 1875 | 2500 | 3750
2812,5 | 3125 | 2136 (HC)

Length mm | 1250 | 1875 | 2500 | 3750
2812,5 | 3125 | 2136 (HC)

DEPTH 1120

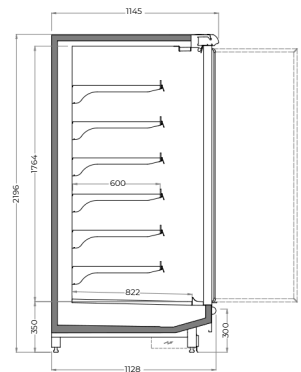
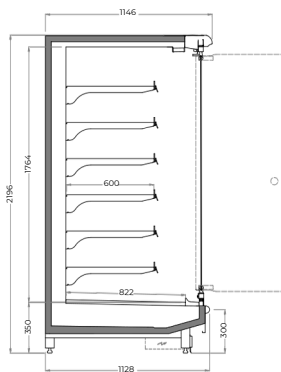
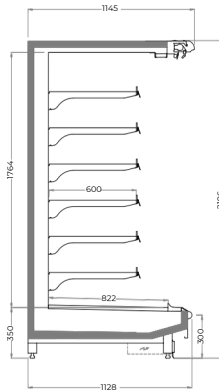

GLINT V3 2200 / 1120

GLINT V3 2200 / 1120

GLINT V3 2200 / 1120

Length mm | 1250 | 1875 | 2500 | 3750
2812,5 | 3125

Length mm | 1250 | 1875 | 2500 | 3750
2812,5 | 3125

Length mm | 1250 | 1875 | 2500 | 3750
2812,5 | 3125

TECHNICAL DATA

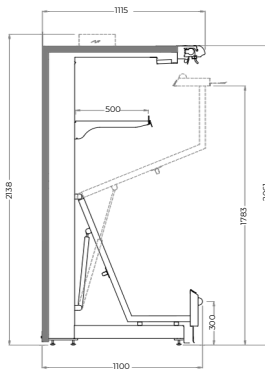

GLINT V3 2050 LIFT UP

Length mm | 1250 | 1875 | 2500 | 3750

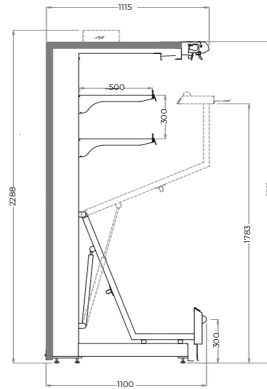

GLINT V3 2200 LIFT UP

Length mm | 1250 | 1875 | 2500 | 3750

ISLAND CONFIGURATION

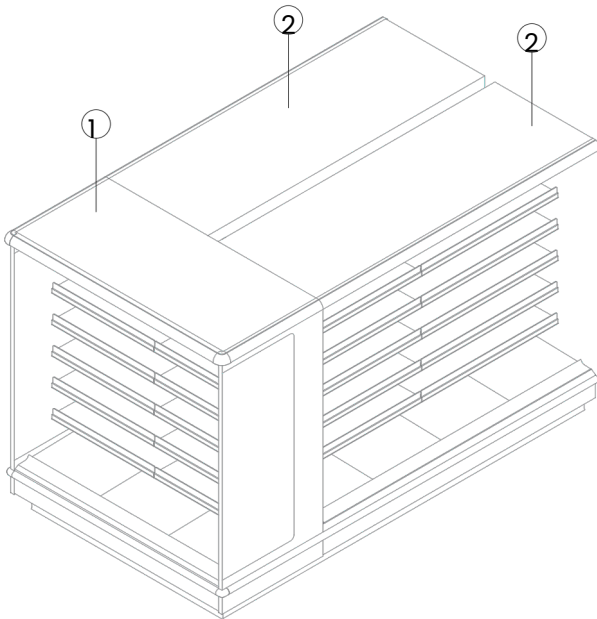

- ① END CASE
- ② RUN CASE

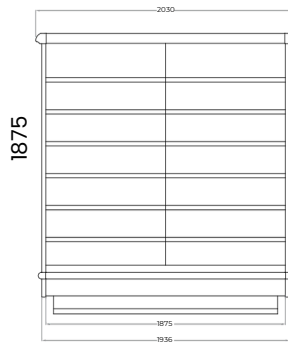

If Glint V3 950 run cabinets are positioned back to back

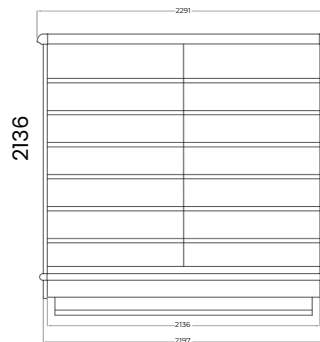
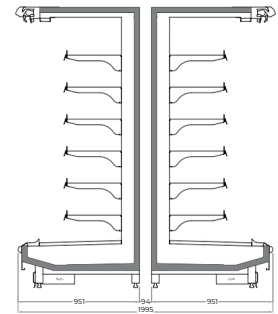

If Glint V3 950 / 1020 run cabinets are positioned back to back

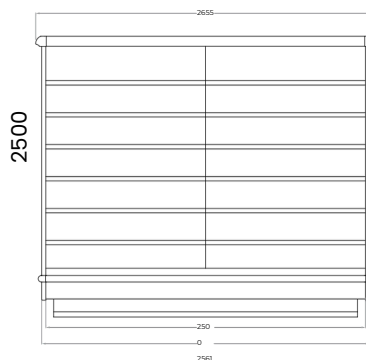
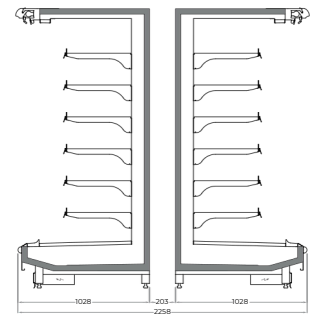

If Glint V3 1120 run cabinets are positioned back to back

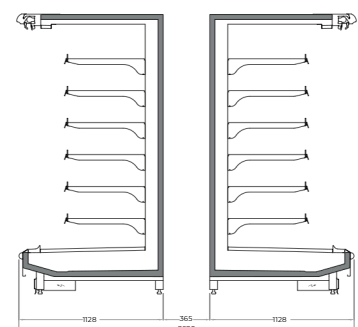

WHERE QUALITY MEETS RELIABILITY

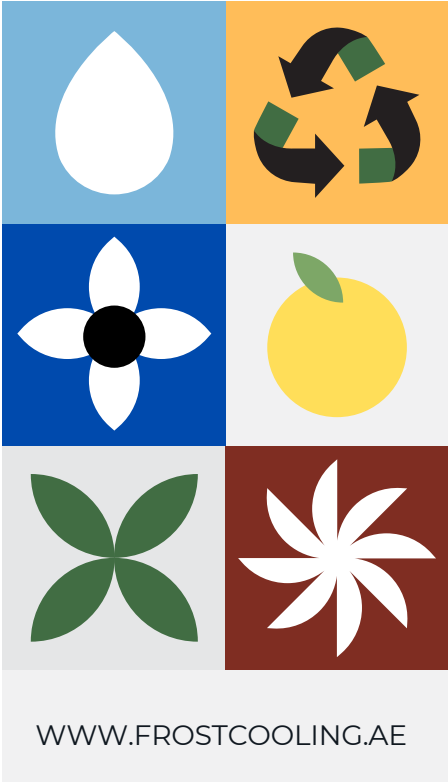

FROST COOLING TRADING
SALES: +971 58 553 8232
OFFICE: +971 58 520 5232
EMAIL: SALES@FROSTCOOLING.AE