

Dimensions							
L(mm) :	1705	H(mm) :	635	W2(mm) :	415	W1(mm) :	555

Performance Data			
Capacity Average Room	8,552.0 Watt	Heat Transfer Surface	31,5 m <sup>2</sup>
Temperature	0.00 °C	Tube Volume	11,0 dm <sup>3</sup>
Evaporation Temperature	-8.00 °C	Fin Spacing	8 mm
ΔT	8 K	Test Pressure / Max. Operating Pressure	34 / 22 bar
Refrigerant	R134A (GWP: 1430)	Energy Efficiency Class	C
Altitude	0 m	Air Throw Distance	17 m

Evaporator Fan Data			
Air Flow	8850 m <sup>3</sup> /h	Fan Protection / Isolation Class	IP 54 / Class F
Number of Fans / Fan Diameter / Fan Speed	2 / 450 mm / 1400 rpm	Operating Temperature Range	60
Nominal Total Power / Current	0.49 kW / 2.2 A	Sound Power Level (LWA)	83 dBA
Fan Voltage / Fan Frequency / Fan Phase	230 Volt / 50 Hz / 1 Ph	Sound Pressure Level (LPA)	61 dBA @ 3 m
Fan Arrangement	1x2		

Configuration	Configuration Name	Code
Fan Option	With EBM Fan	-
Casing Type	ESB Painted Galvanized Steel	-
Fin Material	Aluminum	-
Defrost Type	E2 Defrost [Coil+Pan]	-

Notes.

- Fan data are reference and may vary by brand and model.
- Sound pressure calculation standard: EN13487
- Energy Efficiency Class calculation standards: EN328 and Related Eurovent Standard. Standard Conditions: SC2,R404A
- All of the technical information is subject to change without notice.
- All of the performance and technical data according to default configuration.

**FROST COOLING TRADING LLC**

Location: European Business Center, 3rd Floor, Office No. BC-26, DIP 1, Dubai, U.A.E

Telephone: +971-585205232 Email: sales@frostcooling.ae

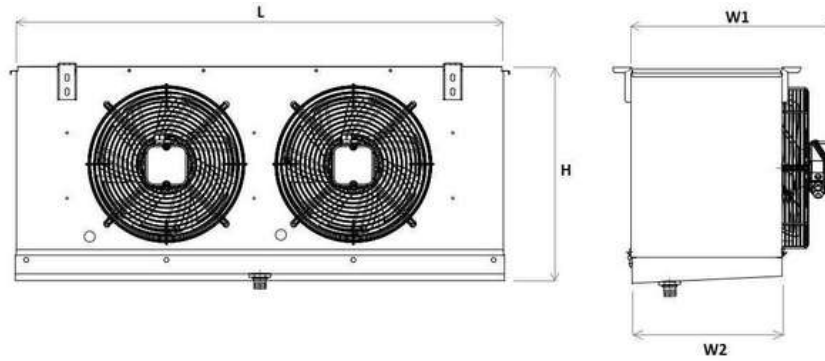

Dimensions							
L(mm) :	1705	H(mm) :	635	W2(mm) :	415	W1(mm) :	555

Performance Data			
Capacity Average Room	9,098.0 Watt	Heat Transfer Surface	31,5 m <sup>2</sup>
Temperature	0.00 °C	Tube Volume	11,0 dm <sup>3</sup>
Evaporation Temperature	-8.00 °C	Fin Spacing	8 mm
ΔT	8 K	Test Pressure / Max. Operating Pressure	34 / 22 bar
Refrigerant	R404A (GWP: 3922)	Energy Efficiency Class	C
Altitude	0 m	Air Throw Distance	17 m

Evaporator Fan Data			
Air Flow	8850 m <sup>3</sup> /h	Fan Protection / Isolation Class	IP 54 / Class F
Number of Fans / Fan Diameter / Fan Speed	2 / 450 mm / 1400 rpm	Operating Temperature Range	60
Nominal Total Power / Current	0.49 kW / 2.2 A	Sound Power Level (LWA)	83 dBA
Fan Voltage / Fan Frequency / Fan Phase	230 Volt / 50 Hz / 1 Ph	Sound Pressure Level (LPA)	61 dBA @ 3 m
Fan Arrangement	1x2		

Configuration	Configuration Name	Code
Fan Option	With EBM Fan	-
Casing Type	ESB Painted Galvanized Steel	-
Fin Material	Aluminum	-
Defrost Type	E2 Defrost [Coil+Pan]	-

- Notes.
- Fan data are reference and may vary by brand and model.
  - Sound pressure calculation standard: EN13487
  - Energy Efficiency Class calculation standards: EN328 and Related Eurovent Standard. Standard Conditions: SC2,R404A
  - All of the technical information is subject to change without notice.
  - All of the performance and technical data according to default configuration.

**FROST COOLING TRADING LLC**

Location: European Business Center, 3rd Floor, Office No. BC-26, DIP 1, Dubai, U.A.E

Telephone: +971-585205232 Email: sales@frostcooling.ae

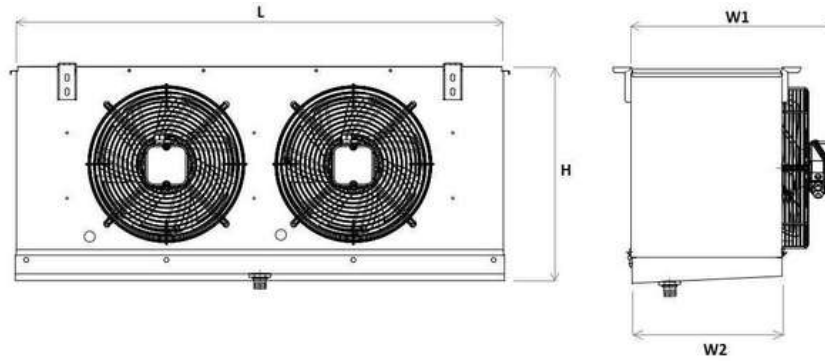

Dimensions							
L(mm) :	1705	H(mm) :	635	W2(mm) :	415	W1(mm) :	555

Performance Data			
Capacity Average Room	6,495.0 Watt	Heat Transfer Surface	31,5 m <sup>2</sup>
Temperature	-18.00 °C	Tube Volume	11,0 dm <sup>3</sup>
Evaporation Temperature	-25.00 °C	Fin Spacing	8 mm
ΔT	7 K	Test Pressure / Max. Operating Pressure	34 / 22 bar
Refrigerant	R404A (GWP: 3922)	Energy Efficiency Class	C
Altitude	0 m	Air Throw Distance	17 m

Evaporator Fan Data			
Air Flow	8850 m <sup>3</sup> /h	Fan Protection / Isolation Class	IP 54 / Class F
Number of Fans / Fan Diameter / Fan Speed	2 / 450 mm / 1400 rpm	Operating Temperature Range	60
Nominal Total Power / Current	0.49 kW / 2.2 A	Sound Power Level (LWA)	83 dBA
Fan Voltage / Fan Frequency / Fan Phase	230 Volt / 50 Hz / 1 Ph	Sound Pressure Level (LPA)	61 dBA @ 3 m
Fan Arrangement	1x2		

Configuration	Configuration Name	Code
Fan Option	With EBM Fan	-
Casing Type	ESB Painted Galvanized Steel	-
Fin Material	Aluminum	-
Defrost Type	E2 Defrost [Coil+Pan]	-

- Notes.
- Fan data are reference and may vary by brand and model.
  - Sound pressure calculation standard: EN13487
  - Energy Efficiency Class calculation standards: EN328 and Related Eurovent Standard. Standard Conditions: SC2,R404A
  - All of the technical information is subject to change without notice.
  - All of the performance and technical data according to default configuration.

**FROST COOLING TRADING LLC**

Location: European Business Center, 3rd Floor, Office No. BC-26, DIP 1, Dubai, U.A.E

Telephone: +971-585205232 Email: sales@frostcooling.ae

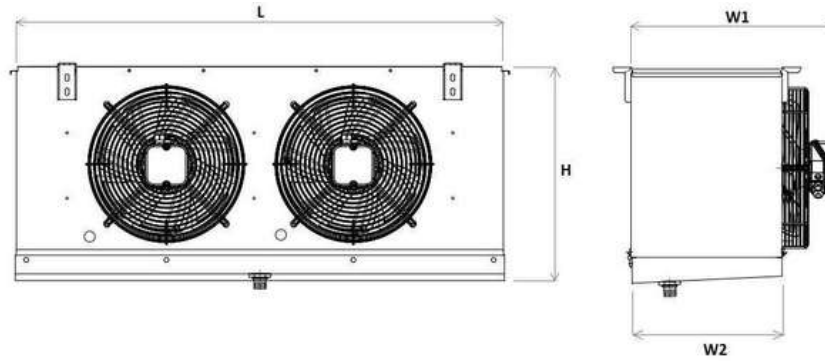

Dimensions							
L(mm) :	1705	H(mm) :	635	W2(mm) :	415	W1(mm) :	555

Performance Data			
Capacity Average Room	5,390.0 Watt	Heat Transfer Surface	31,5 m <sup>2</sup>
Temperature	-18.00 °C	Tube Volume	11,0 dm <sup>3</sup>
Evaporation Temperature	-25.00 °C	Fin Spacing	8 mm
ΔT	7 K	Test Pressure / Max. Operating Pressure	34 / 22 bar
Refrigerant	R134A (GWP: 1430)	Energy Efficiency Class	C
Altitude	0 m	Air Throw Distance	17 m

Evaporator Fan Data			
Air Flow	8850 m <sup>3</sup> /h	Fan Protection / Isolation Class	IP 54 / Class F
Number of Fans / Fan Diameter / Fan Speed	2 / 450 mm / 1400 rpm	Operating Temperature Range	60
Nominal Total Power / Current	0.49 kW / 2.2 A	Sound Power Level (LWA)	83 dBA
Fan Voltage / Fan Frequency / Fan Phase	230 Volt / 50 Hz / 1 Ph	Sound Pressure Level (LPA)	61 dBA @ 3 m
Fan Arrangement	1x2		

Configuration	Configuration Name	Code
Fan Option	With EBM Fan	-
Casing Type	ESB Painted Galvanized Steel	-
Fin Material	Aluminum	-
Defrost Type	E2 Defrost [Coil+Pan]	-

- Notes.
- Fan data are reference and may vary by brand and model.
  - Sound pressure calculation standard: EN13487
  - Energy Efficiency Class calculation standards: EN328 and Related Eurovent Standard. Standard Conditions: SC2,R404A
  - All of the technical information is subject to change without notice.
  - All of the performance and technical data according to default configuration.

**FROST COOLING TRADING LLC**

Location: European Business Center, 3rd Floor, Office No. BC-26, DIP 1, Dubai, U.A.E

Telephone: +971-585205232 Email: sales@frostcooling.ae