



# VECTO SKY

VERTICAL MULTI-DECK with WIDE LOOK DOOR





### Benefits & Specifications:

- Canopyless
- High end design
- Designed for modular configurations
- Practical design for simple installation and maintenance
- Efficient in energy consumption with higher evaporation temperature
- Full length frameless glassdoors
- Elegant glass wall effect
- Customized solutions for individual needs
- Uses less energy while operating
- Delivers high standard of performance
- Built-in durability

### Dimensions (mm):

Height : 2050 / 2200 Length : Run Cabinets : 1250 / 1875 / 2500 / 3750

End Cabinets : 1660 / 1875 / 2136

Depth : 850 / 950 / 1090

SYSTEM	OPERATING TEMP. °C	REFRIGERANT
REMOTE	-1 / +1 +2 / +4	HFC blend HFC/HFO blend CO <sub>2</sub> GLYCOL/WATER

HFC: R407A / R407F / R134a / R404A • HFC/HFO: R448A / R449A / R452A / R450A  
CO<sub>2</sub>: R744 • GLYCOL/WATER: R718



# ACCESSORIES

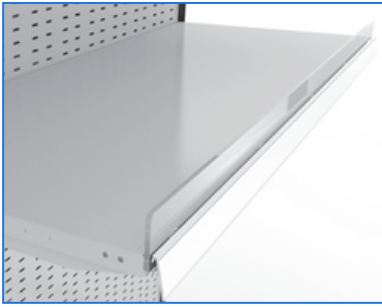

SOLID SHELF

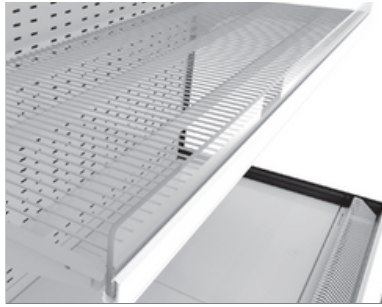

WIRE SHELF

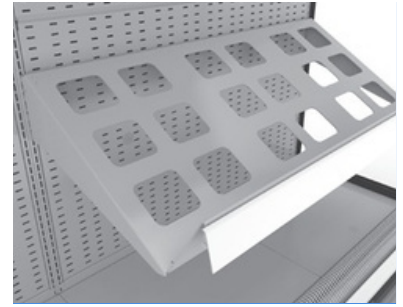

RACK SHELF

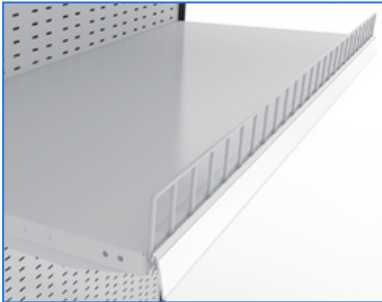

WIRE SHELF RISER



PLEXI SHELF RISER

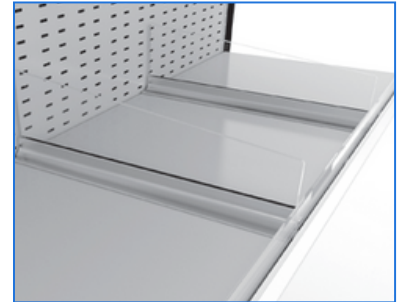

PLEXI PRODUCT DIVIDER

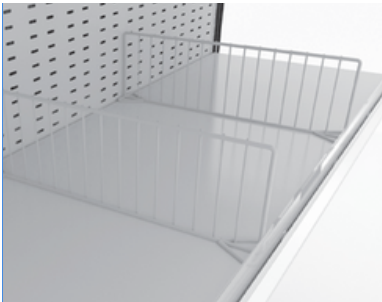

WIRE PRODUCT DIVIDER



SHELF LIGHTING

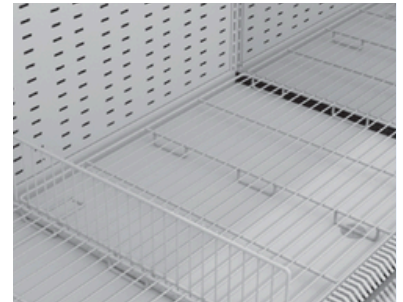

WIRE BASE TRAY  
WIRE BASE PRODUCT DIVIDER

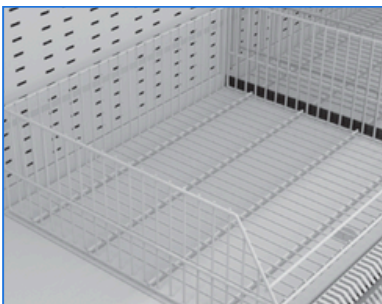

WIRE BASKET

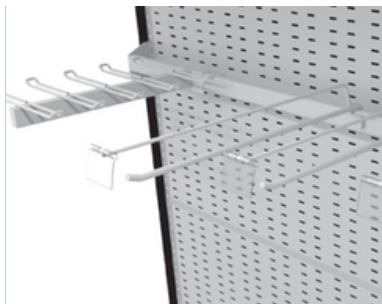

HOOK BAR



CABINET UPSTAND

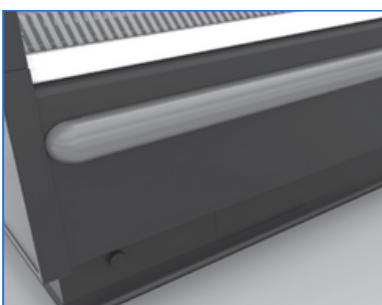

PLASTIC BUMPRAIL

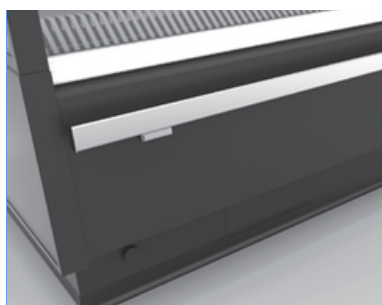

STAINLESS STEEL BUMPRAIL

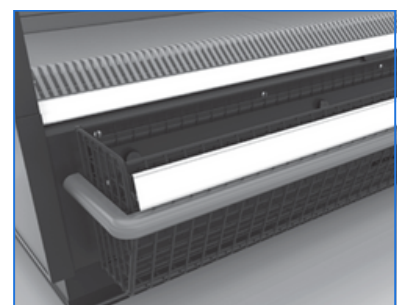

BASE FRONT CRISP BASKET



NIGHT BLIND

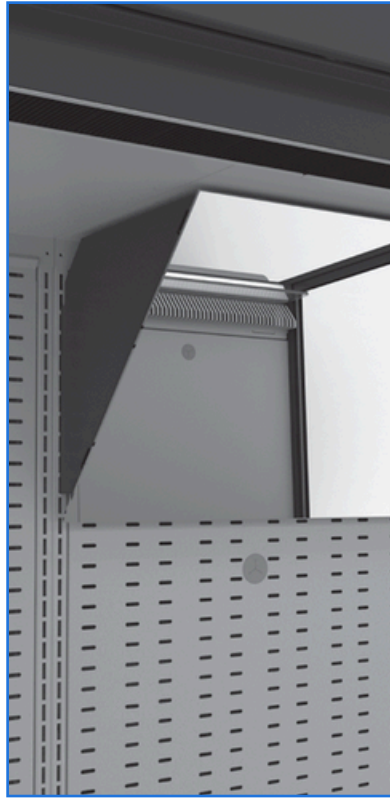

MIRROR (FV & MT)



ACRYLIC SYSTEM DIVIDE



PANAROMIC SIDE PANEL



INTERMEDIATE SIDE PANEL



MIRRORED SIDE PANEL

# TECHNICAL DATA

DEPTH 850

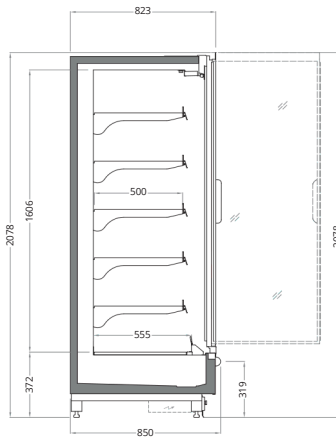

**VECTO SKY 2050 / 850 / 320**  
 Length mm | 1250 | 1875 | 2500 | 3750 | HC:1660

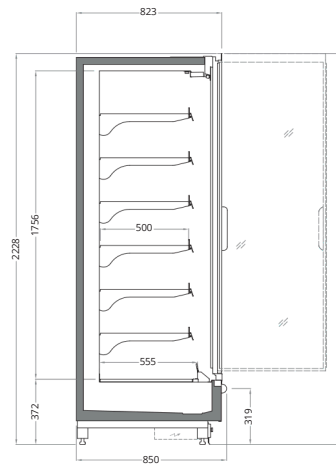

**VECTO SKY 2200 / 850 / 320**  
 Length mm | 1250 | 1875 | 2500 | 3750 | HC:1660

DEPTH 950

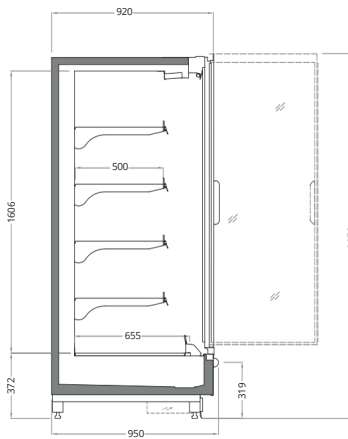

**VECTO SKY 2050 / 950 / 320**  
 Length mm | 1250 | 1875 | 2500 | 3750 | HC:1875

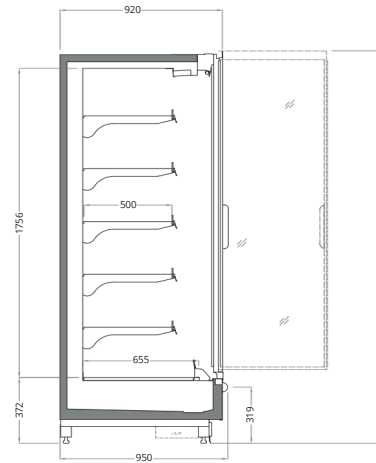

**VECTO SKY 2200 / 950 / 320**  
 Length mm | 1250 | 1875 | 2500 | 3750 | HC:1875

DEPTH 1090

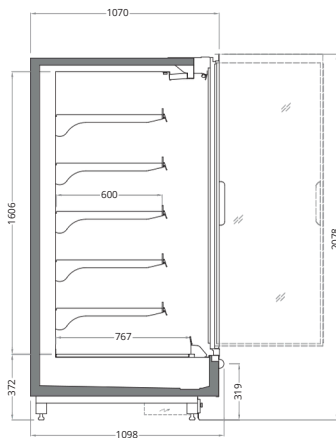

**VECTO SKY 2050 / 1090 / 320**  
 Length mm | 1250 | 1875 | 2500 | 3750 | HC:2136

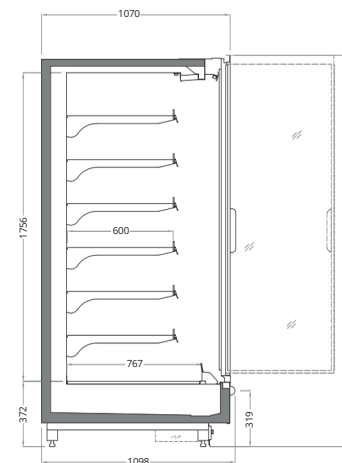

**VECTO SKY 2200 / 1090 / 320**  
 Length mm | 1250 | 1875 | 2500 | 3750 | HC:2136

# ISLAND CONFIGURATION

① END CASE

② RUN CASE

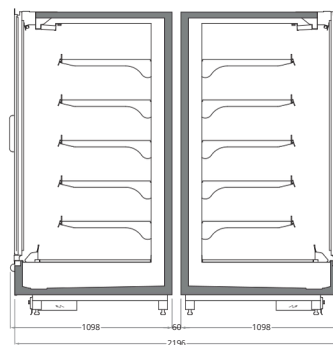
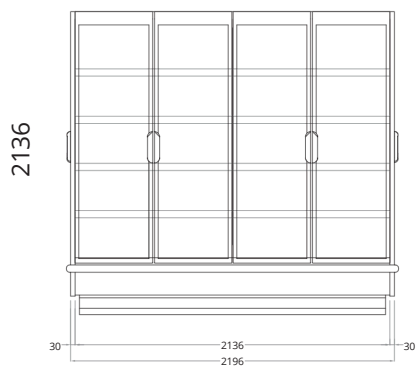
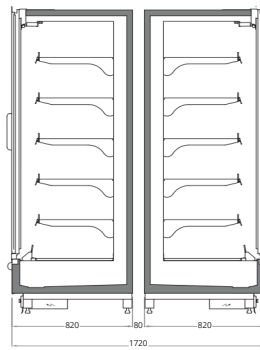
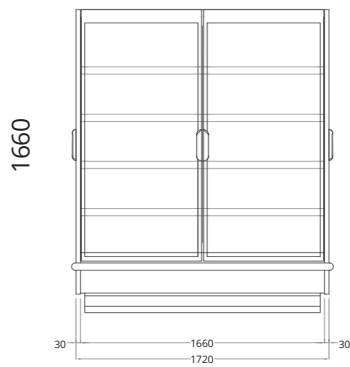
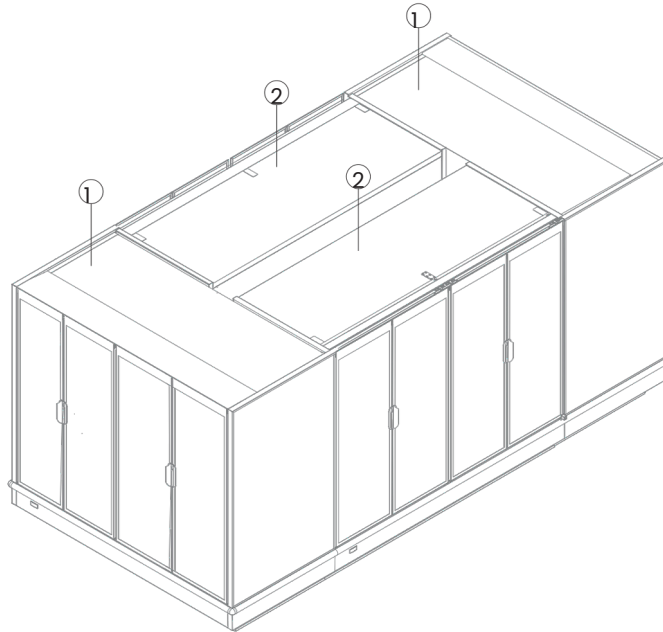

# WHERE QUALITY MEETS RELIABILITY

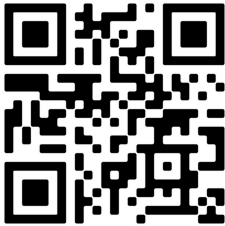
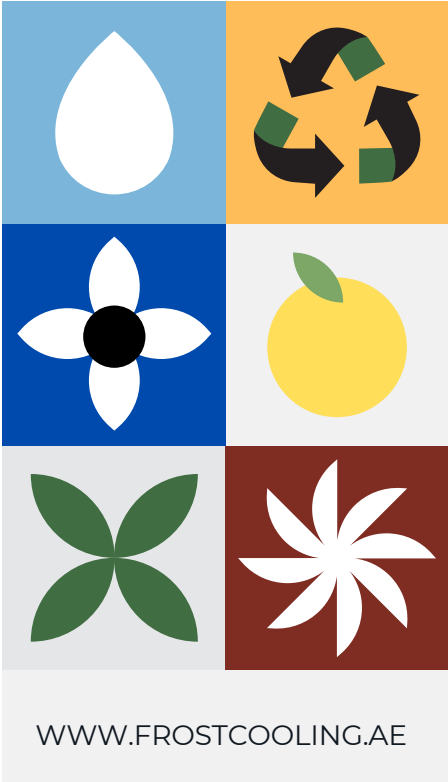

**FROST COOLING TRADING**  
SALES: +971 58 553 8232  
OFFICE: +971 58 520 5232  
EMAIL: SALES@FROSTCOOLING.AE